

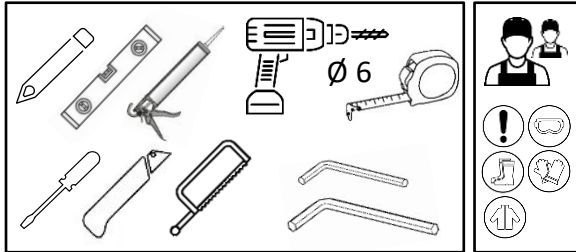















PRELUDE PLUS

Dušas durvju montāžas instrukcija

Инструкция по монтажу душевой двери

Shower door installation instructions



1.		PAL-01	1
2.		PAL-01B	1
3.		SU45CH + SK2SET1	1
4.		GC-2032	1
5.		MF-43MAGN	1
6.		MF-42/8-ER	1
7.		R1653308	1
8.		400211PS-013	1
9.		SC-ALU8X9NEW	1
10.R		SC-SL-UZL180R	1
10.L		SC-SL-UZL180L	1
11.		OSH-OFS2CP	2
12.		DR-CH32	1
13.		3,5x35 SK1SET; Ø 6	2
14.		8 mm Safety Glass	1
15.		8 mm Safety Glass	1

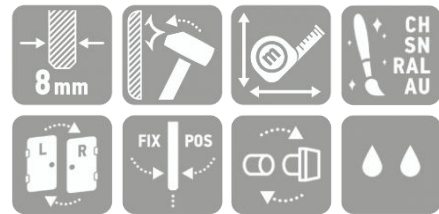
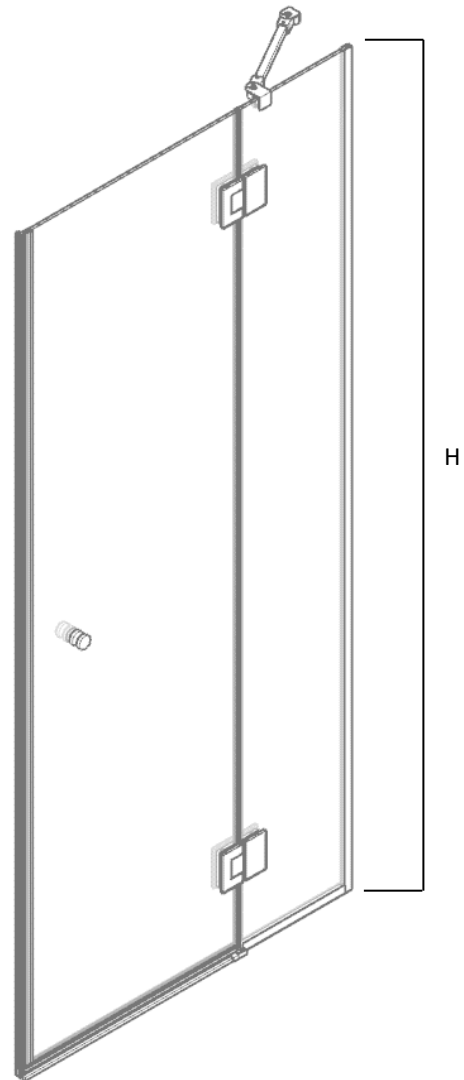

LEFT

RIGHT

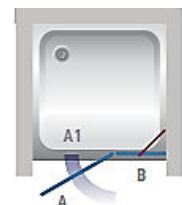
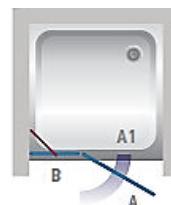

PRELUDE PLUS	A + B (mm)	B (mm)	H (mm)
70PRE+	698-703	200	1988
80PRE+	798-803	200	1988
90PRE+	898-903	300	1988
100PRE+	998-1003	300	1988
110PRE+	1098-1103	400	1988
120PRE+	1198-1203	500	1988

PRELUDE PLUS

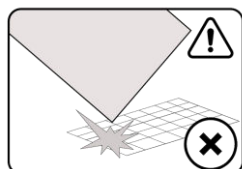
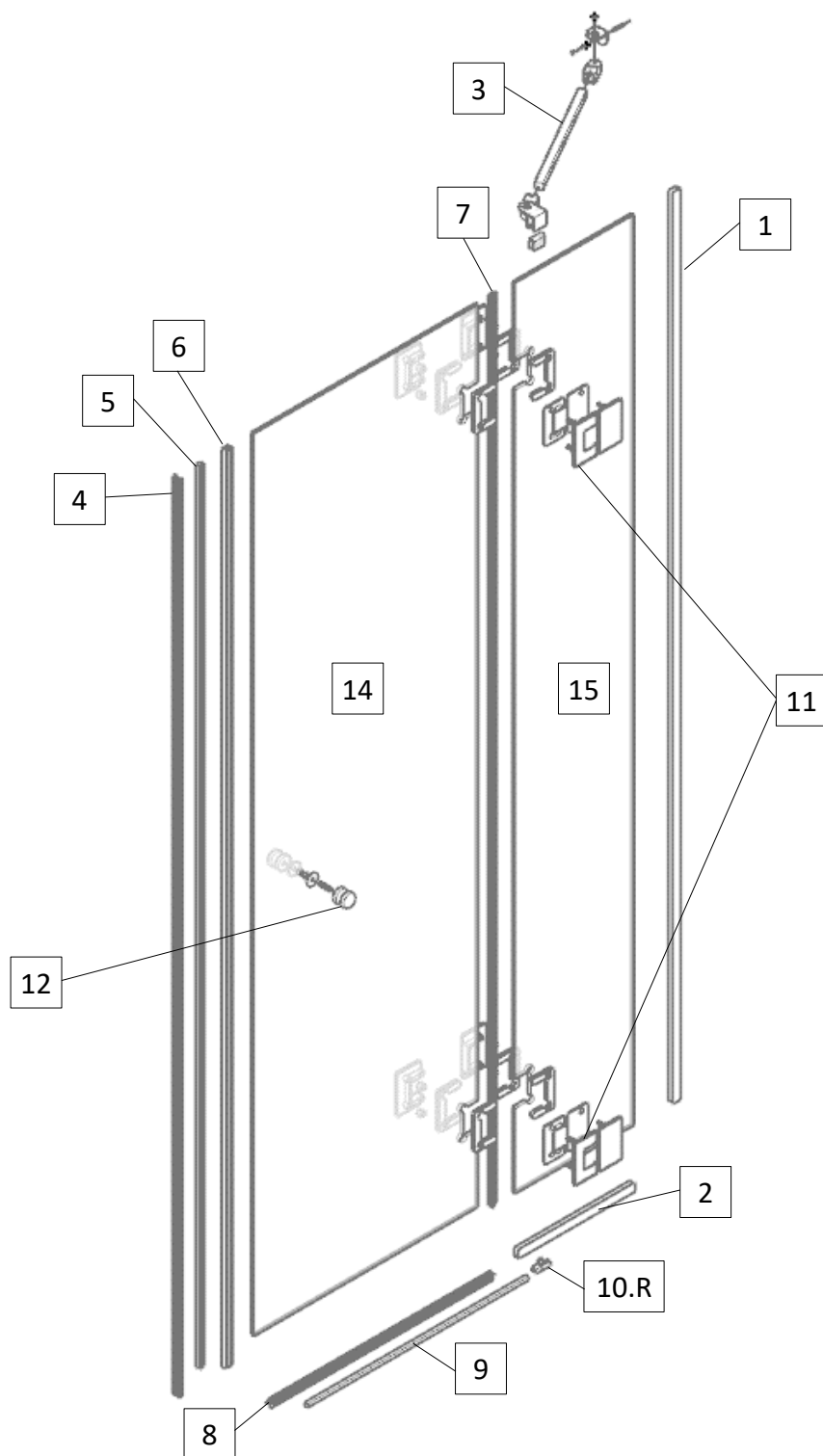

Uzmanību! Rūdīts stikls- rīkojieties uzmanīgi. Aizsargājiet stikla stūrus pret triecieniem.

Внимание! Закаленное стекло – будьте осторожны. Защищайте углы стекла от ударов.

Attention! Tempered glass - proceed with care. Protect the corners of the glass from impact.

