

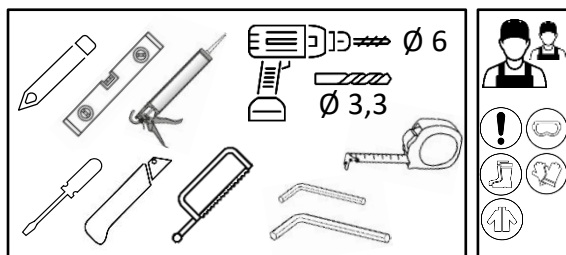













MONIKA BLACK

Dušas kabīnes montāžas instrukcija

Инструкция по монтажу душевой кабины

Shower enclosure installation assembly



1.		PAL-01	1
2.		PAL-01B	1
3.		DZT100CHR10X20	1
4.		MF-42/8-ER	1
5.		40021PS - 009	2
6.		400211PS-013	1
7.		W981L/ W981R	2
8.		NLO-ZD-2856	1
9.		SC-ALU8X9NEW	1
10.R		SC-SL-UZL90L	1
10.L		SC-SL-UZL90R	1
11.		3,5x35 SK1SET; Ø 6	1
12.		8 mm Safety Glass	1
13.		8 mm Safety Glass	1

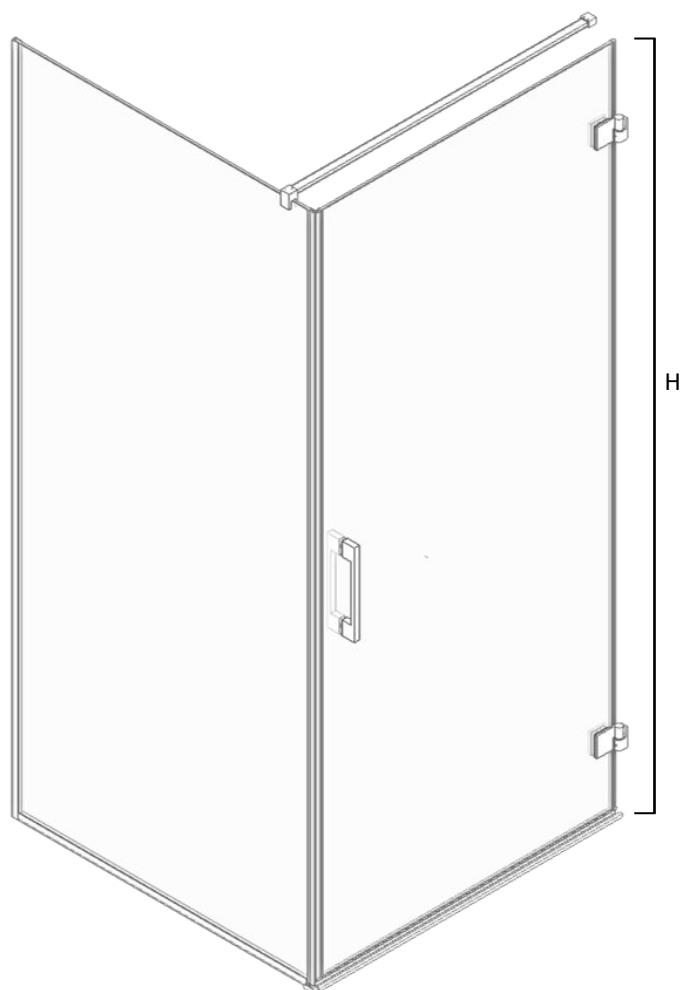

LEFT

RIGHT



MONIKA BLACK	A (mm)	B (mm)	H (mm)
70X70MONI_B	692-695	687-692	1988
80X80MONI_B	792-795	787-792	1988
90X90MONI_B	892-895	887-892	1988

MONIKA BLACK

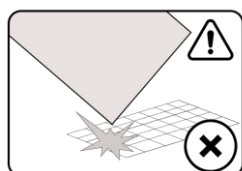
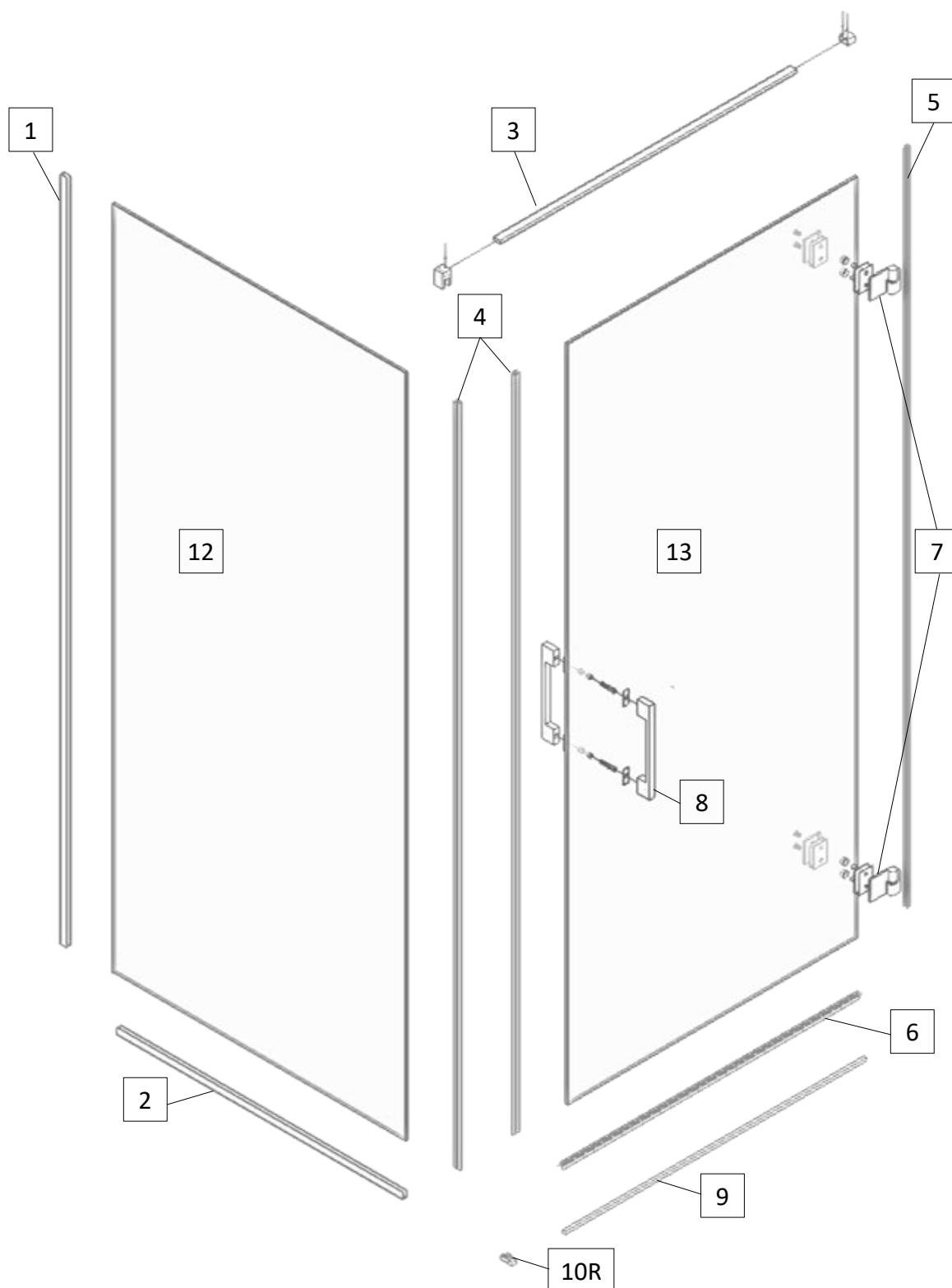

Uzmanību! Rūdīts stikls- rīkojieties uzmanīgi. Aizsargājiet stikla stūrus pret triecieniem.

Внимание! Закаленное стекло – будьте осторожны. Защищайте углы стекла от ударов.

Attention! Tempered glass - proceed with care. Protect the corners of the glass from impact.

1.A

MONIKA	P, mm	A1, mm	B1, mm
70X70MONI	700 x 700	686	683
80X80MONI	800 x 800	786	783
90X90MONI	900 x 900	886	883

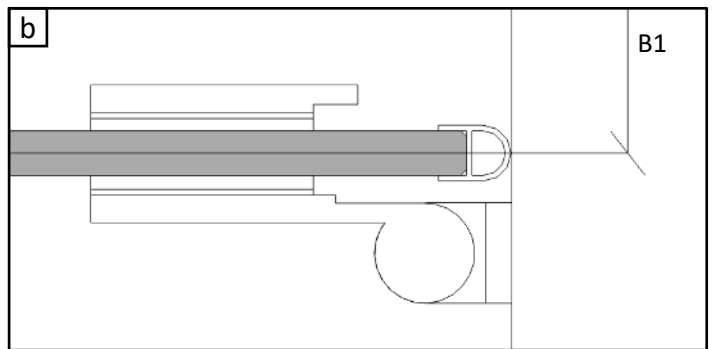
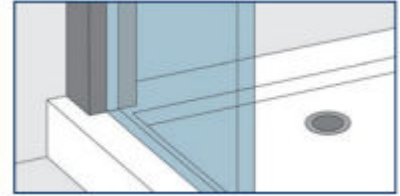
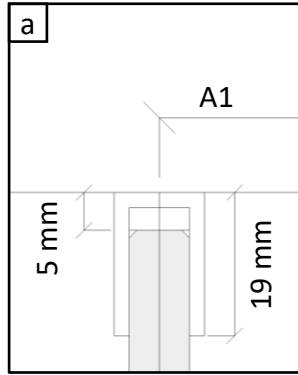
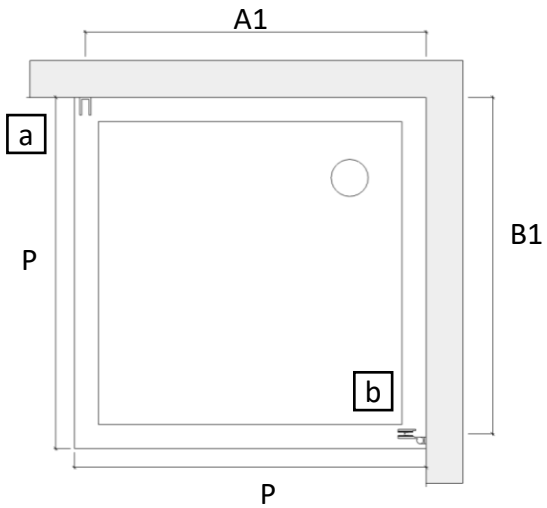

1.B

MONIKA	D	S
70X70MONI	700	700
80X80MONI	800	800
90X90MONI	900	900

