

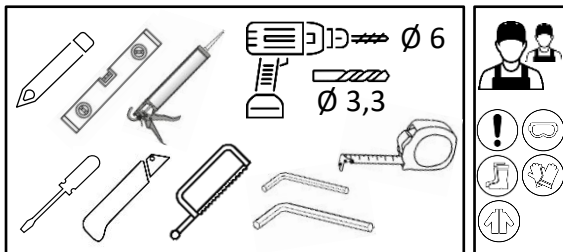















# MARTINA

## Dušas durvju montāžas instrukcija

Инструкция по монтажу душевой двери

Shower door installation instructions



1.		PAL-01	1
2.		PAL-01B	1
3.		SU45CH + SK2SET1	1
4.		VIRA20CH	1
5.		MF-42/8-ER	1
6.		MF-36/6-ER	1
7.		R1656715	1
8.		SC-ALU8X9NEW	1
9.		SC-SL-UZL180R	1
10.		SC-SL-UZL180L	1
11.		DR-CH32	1
12.		3,5x35 SK1SET; Ø 6	2
13.		3,5x13 SK2SET	2
14.		6 mm Safety Glass + VIRA20CH	1
15.		8 mm Safety Glass	1

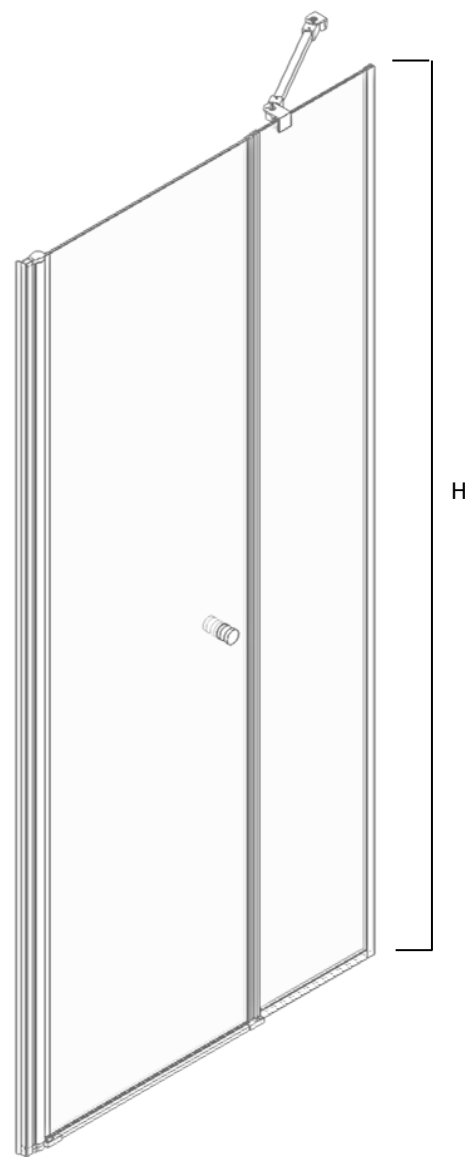

LEFT

RIGHT

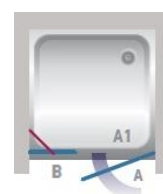
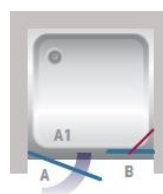

MARTINA	A+B (mm)	B (mm)	H (mm)
70MAR	695-703	200	1988
80MAR	795-803	200	1988
90MAR	895-903	300	1988
100MAR	995-1003	300	1988
110MAR	1095-1103	400	1988
120MAR	1198-1203	500	1988

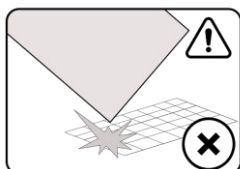
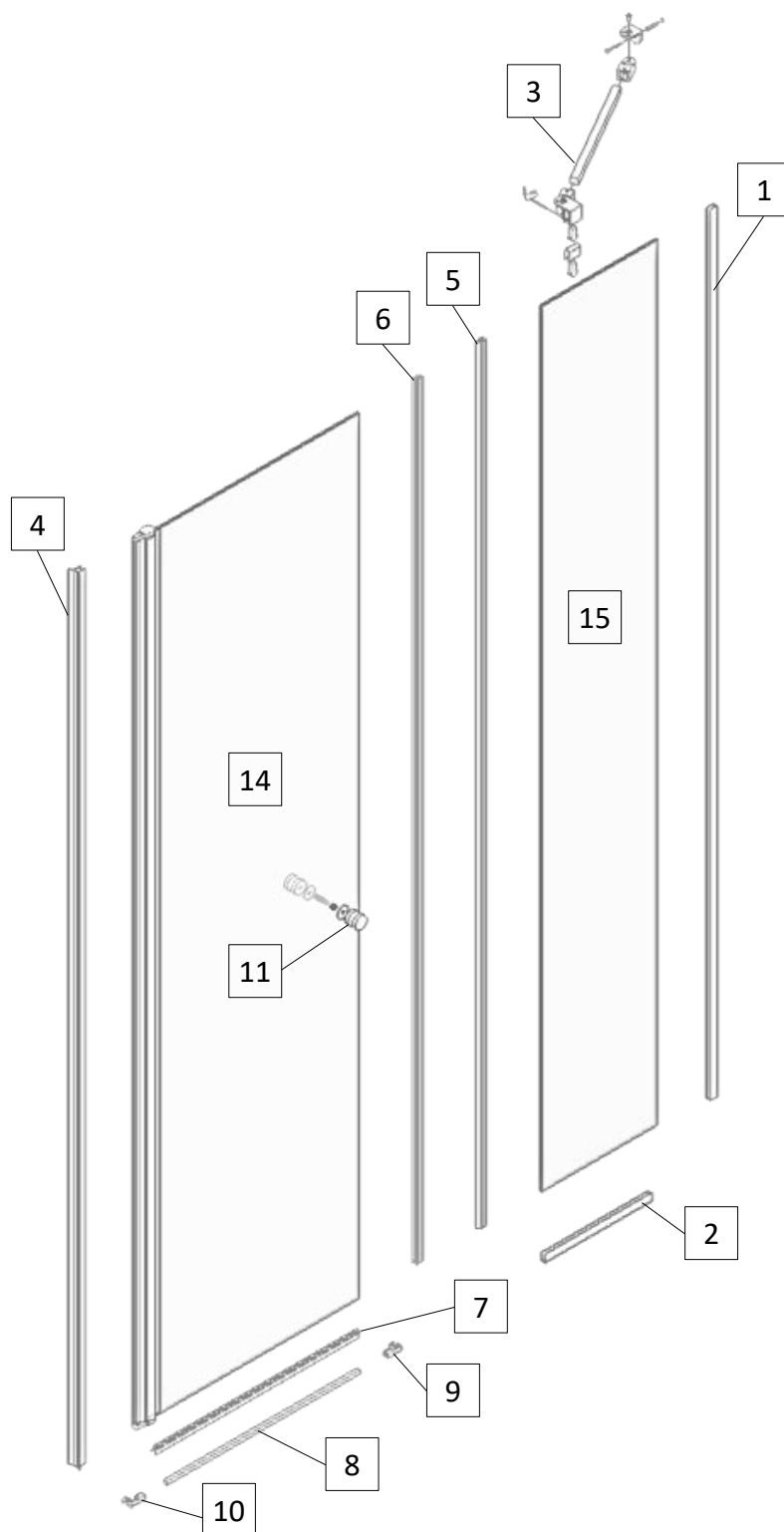

**Uzmanību!** Rūdīts stikls- rīkojieties uzmanīgi. Aizsargājiet stikla stūrus pret triecieniem.

**Внимание!** Закаленное стекло – будьте осторожны. Защищайте углы стекла от ударов.

**Attention!** Tempered glass - proceed with care. Protect the corners of the glass from impact.

