

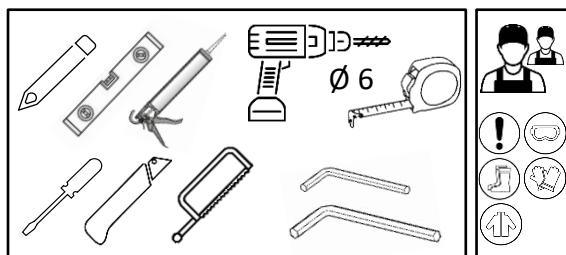













# LUISA

## Dušas durvju montāžas instrukcija

Инструкция по монтажу душевой двери

Shower door installation instructions

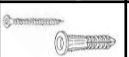

1.		PAL-01	2
2.		PAL-01B	2
3.		SU45CH + SK2SET1	2
4.		MF-42/8-ER	1
5.		R1653308	1
6.		400211PS-013	1
7.		SC-ALU8X9NEW	1
8.		SC-SL-UZL180R	1
9.		SC-SL-UZL180L	1
10.		OSH-OFS2CP	2
11.		DR-CH32	1
12.		3,5x35 SK1SET; Ø 6	2
13.		8 mm Safety Glass	1
14.		8 mm Safety Glass	1
15.		8 mm Safety Glass	1

LUISA	A + BB (mm)	B (mm)	H (mm)
80LUI	798-803	150/150	1988
90LUI	898-903	200/200	1988
100LUI	998-1003	200/200	1988
110LUI	1098-1103	200/200	1988
120LUI	1198-1203	250/250	1988
130LUI	1298-1303	300/300	1988
140LUI	1398-1403	350/350	1988

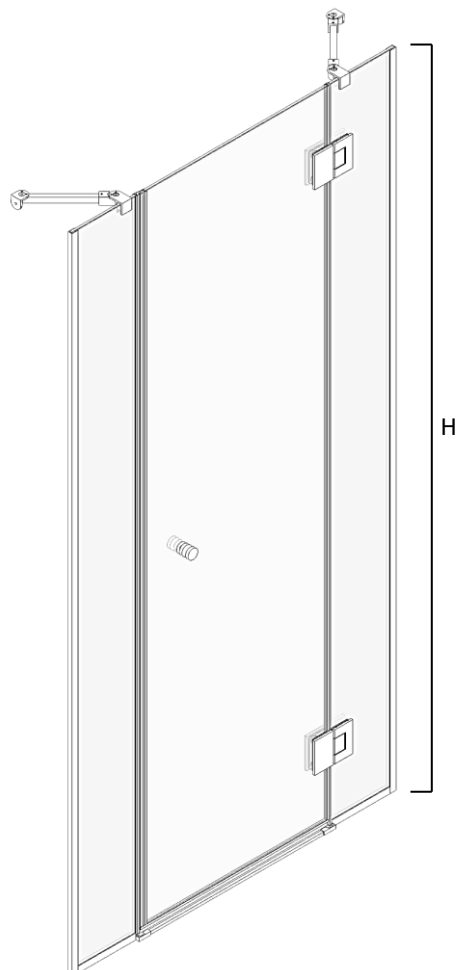

LEFT

RIGHT

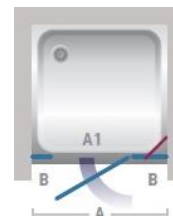
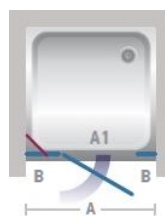

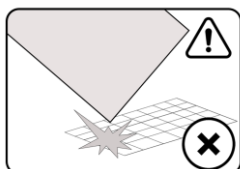
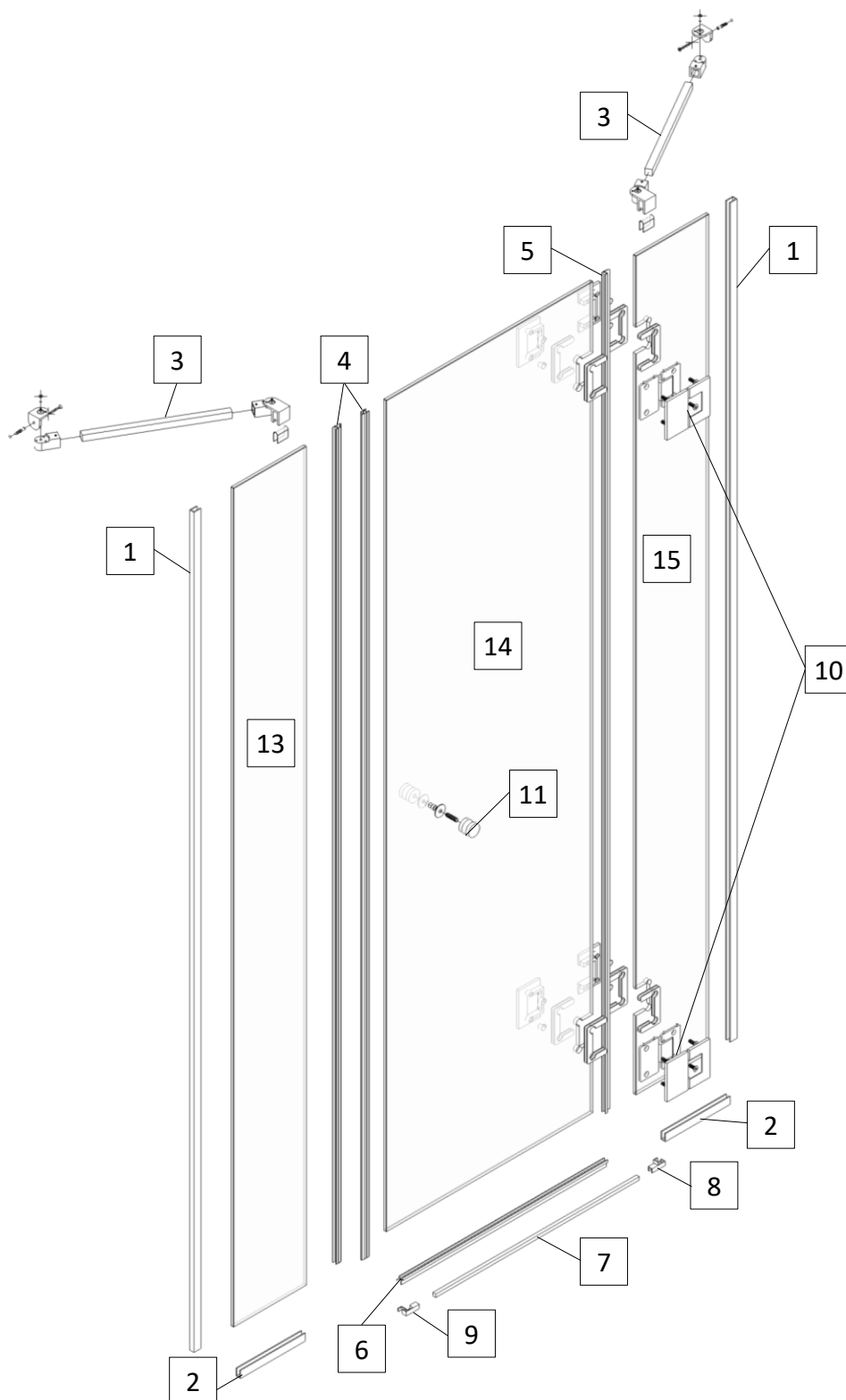

**Uzmanību!** Rūdīts stikls- rīkojieties uzmanīgi. Aizsargājiet stikla stūrus pret triecieniem.

**Внимание!** Закаленное стекло – будьте осторожны. Защищайте углы стекла от ударов.

**Attention!** Tempered glass - proceed with care. Protect the corners of the glass from impact.

