

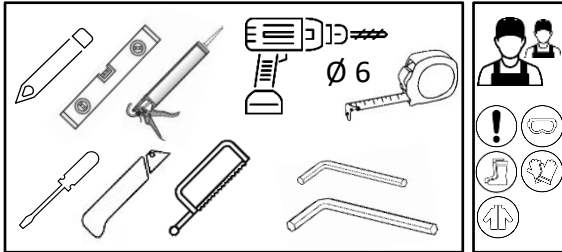













# KARIN PLUS

## Dušas durvju montāžas instrukcija

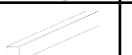
Инструкция по монтажу душевой двери

Shower door installation instructions

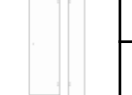

1.		PAL-01	1
2.		PAL-01B	1
3.		SU45CHKANT + SK2SET	1
4.		GC-2032	1
5.		MF-43MAGN	1
6.		MF-42/8-ER	1
7.		R1653308	2
8.		400211PS-013	1
9.		SC-ALU8X9NEW	1
10.R		SC-SL-UZL180R	1
10.L		SC-SL-UZL180L	1
11.		PSDK-05	1
12.		SSPBH-772	2
13.		3,5X35 SK1SET; Ø 6	2
14.		8mm Safety Glass	1
15.		8mm Safety Glass	1

KARIN PLUS	A (mm)	B (mm)	H (mm)
70KAR+	698-703	200	1988
80KAR+	798-803	200	1988
90KAR+	898-903	300	1988
100KAR+	998-1003	300	1988
110KAR+	1098-1103	400	1988
120KAR+	1198-1203	500	1988

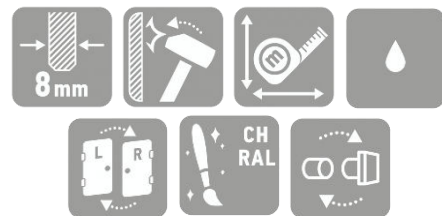
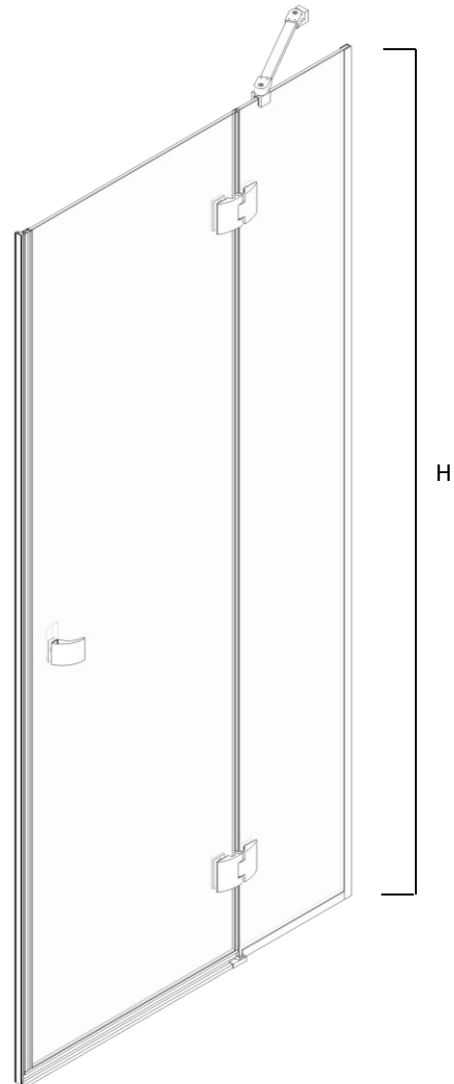

LEFT

RIGHT

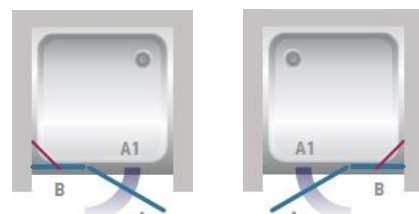

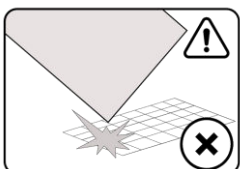
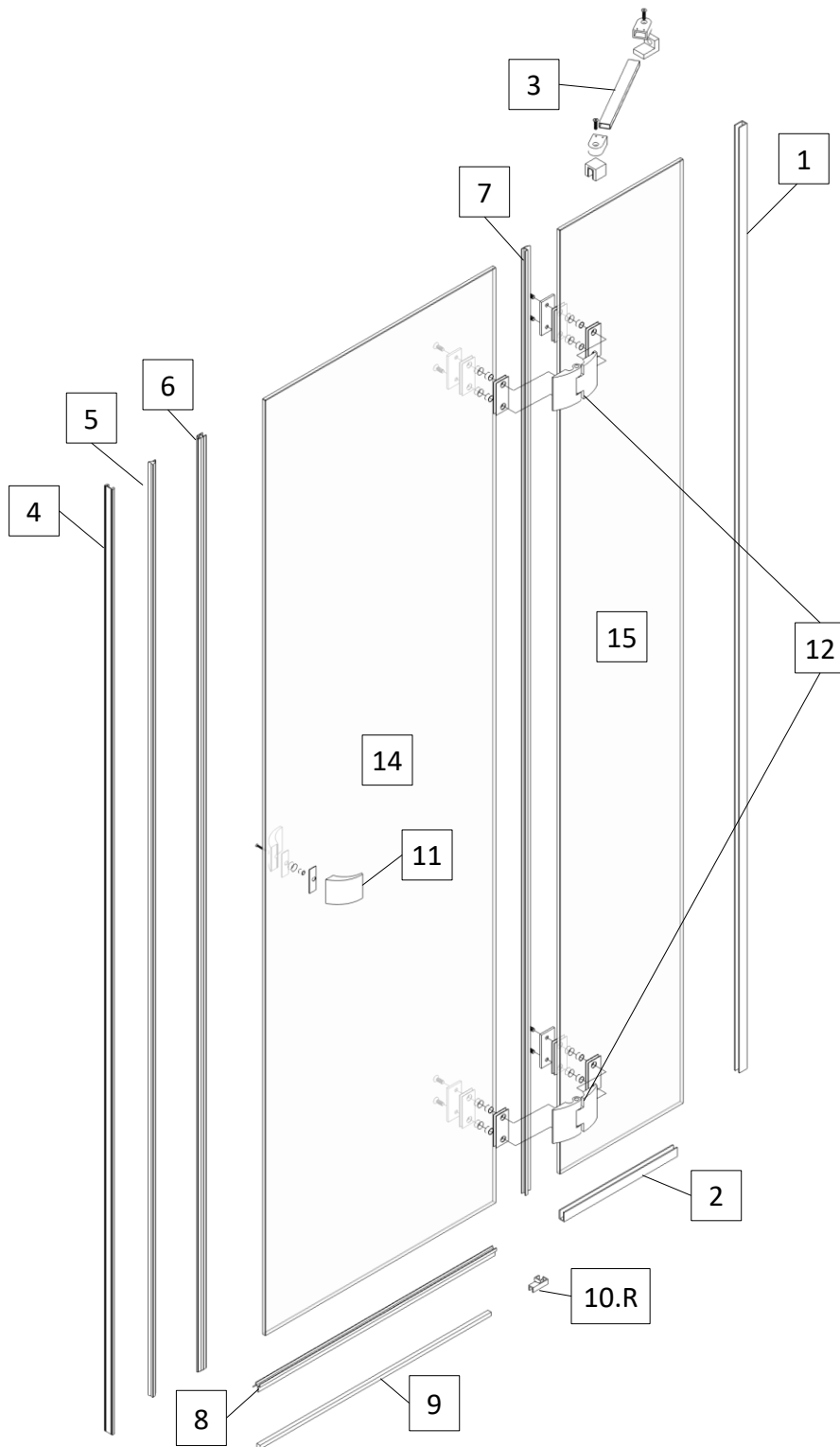

**Uzmanību!** Rūdīts stikls- rīkojieties uzmanīgi. Aizsargājiet stikla stūrus pret triecieniem.

**Внимание!** Закаленное стекло – будьте осторожны. Защищайте углы стекла от ударов.

**Attention!** Tempered glass - proceed with care. Protect the corners of the glass from impact.

