

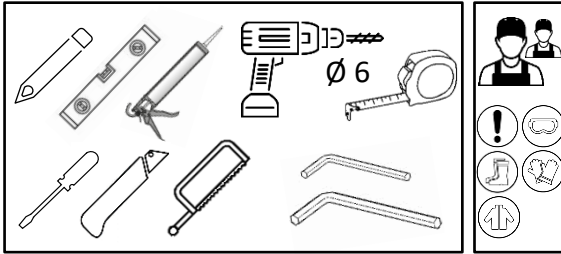

















CARLOTTA

Dušas kabīnes montāžas instrukcija

Инструкция по монтажу душевой кабины
Shower enclosure installation assembly



1.		PAL-01	2
2.		PAL-01B	1
3.		PAL-02B	1
4.		DZT1000CHR	1
5.		MF-42/8-ER	1
6.		R1653308	1
7.		400211PS-013	1
8.		PSDF-4CAR-180CH	2
9.		PGB-913-CH	2
10.		NLO-ZD-2856	1
11.		SC-ALU8X9NEW	1
12.R		SC-SL-UZL90L	1
13.R		SC-SL-UZL180R	1
12.L		SC-SL-UZL180L	1
13.L		SC-SL-UZL90R	1
14.		3,5x35 SK1SET; Ø 6	2
15.		8 mm Safety Glass	1
16.		8 mm Safety Glass	1
17.		8 mm Safety Glass	1

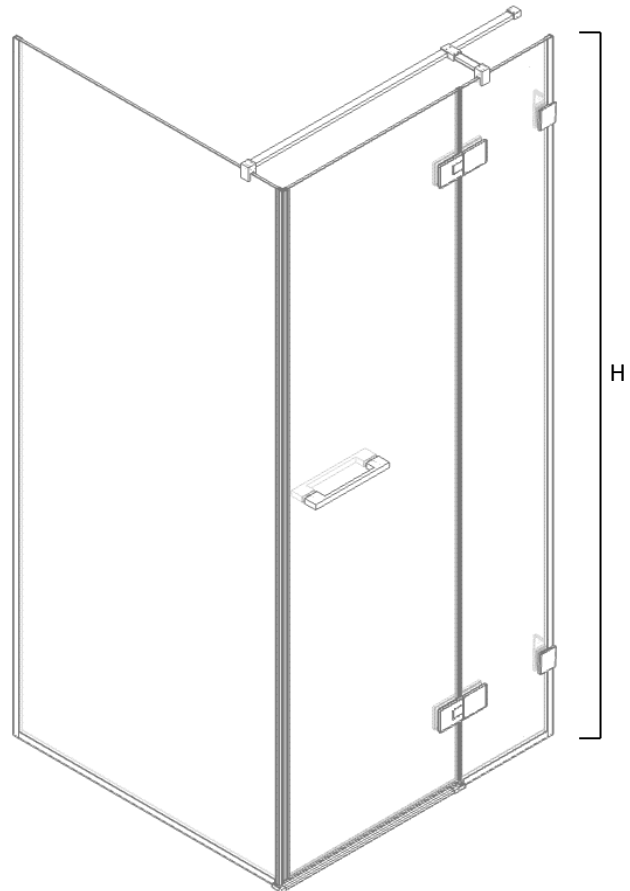

CARLOTTA	A + B (mm)	C (mm)	H (mm)
80X80CAR	794-800	787-792	1988
90X90CAR	894-900	887-892	1988
100X100CAR	994-1000	987-992	1988
110X110CAR	1094-1100	1087-1092	1988
120X120CAR	1194-1200	1187-1192	1988
120X80CAR	1194-1200	787-792	1988
120X90CAR	1194-1200	887-892	1988

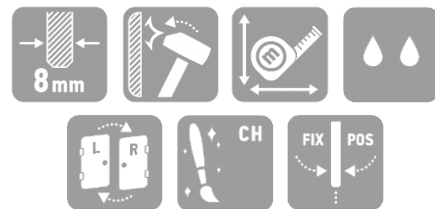

LEFT

RIGHT

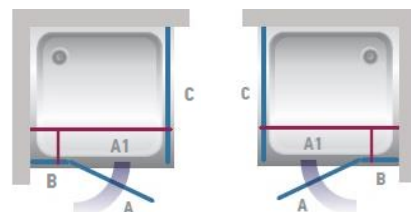

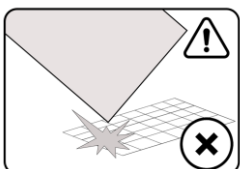
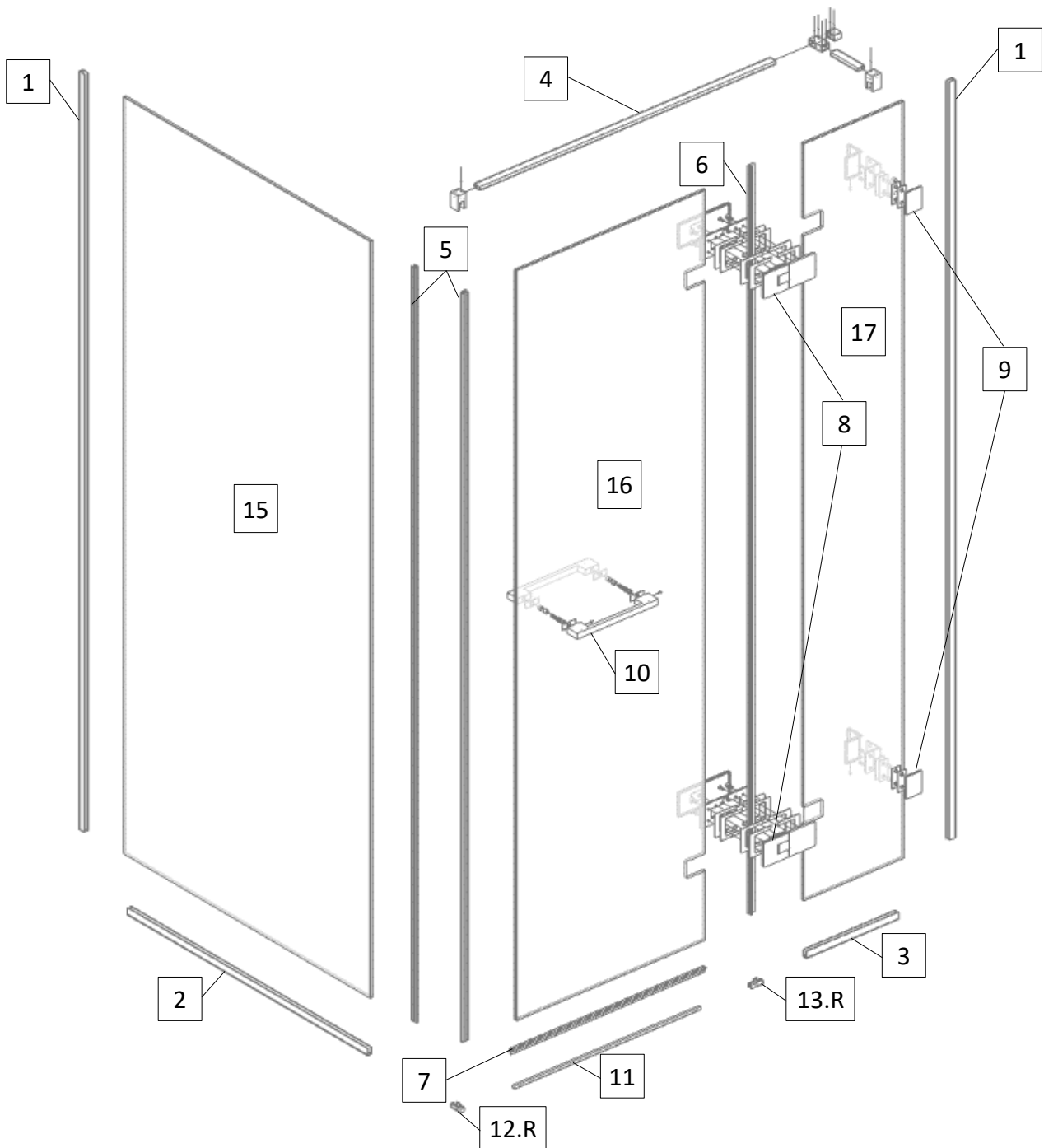

Uzmanību! Rūdīts stikls- rīkojieties uzmanīgi. Aizsargājiet stikla stūrus pret triecieniem.

Внимание! Закаленное стекло – будьте осторожны. Защищайте углы стекла от ударов.

Attention! Tempered glass - proceed with care. Protect the corners of the glass from impact.

1.A

CARLOTTA	P, mm	A+B1, mm	C, mm
80X80CAR	800 x 800	788	783
90X90CAR	900 x 900	888	883
100X100CAR	1000 x 1000	988	983
110X110CAR	1100 x 1100	1088	1083
120X120CAR	1200 x 1200	1188	1183
120X80CAR	1200 x 800	1188	783
120X90CAR	1200 x 900	1188	883

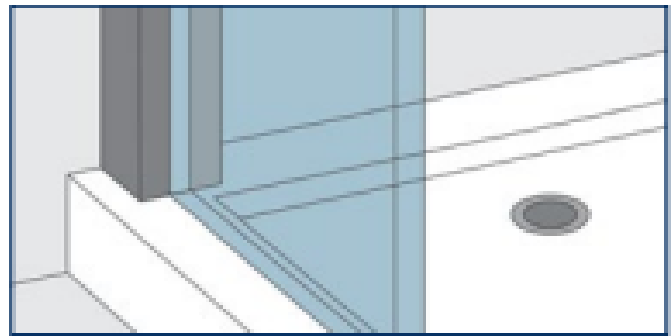
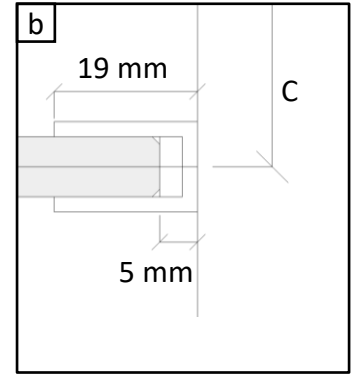
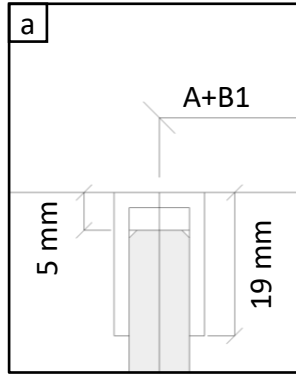
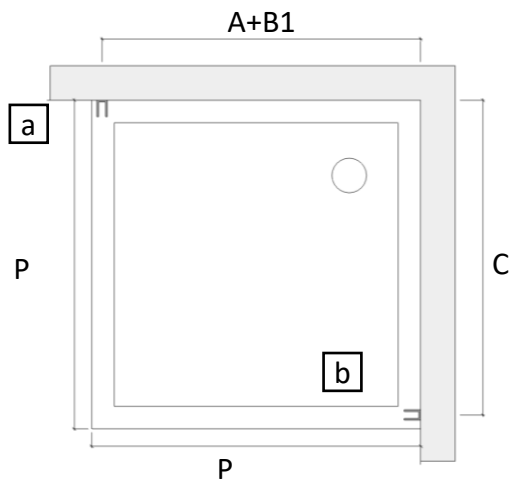

1.B

CARLOTTA	D	S
80X80CAR	800	800
90X90CAR	900	900
100X100CAR	1000	1000
110X110CAR	1100	1100
120X120CAR	1200	1200
120X80CAR	1200	1200
120X90CAR	1200	1200

