

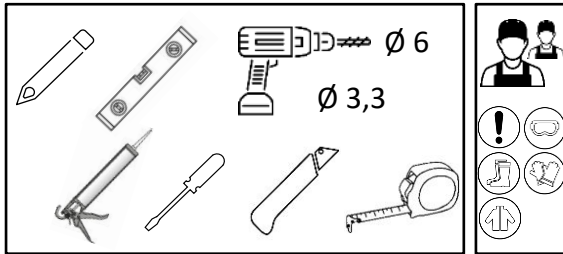















ANITA

Vannas sienas montāžas instrukcija

Инструкция по монтажу ванной стены

Bath screen installation instructions



1.		R22-01	1
2.		R22-02	1
3.		R22-03	1
4.		R22-04	1
5.		R22-05	1
6.		R22-06	1
7.		R22-07	1
8.		R22-08	1
9.		R22-09	1
10.		R22-10	2
11.		R22-11	3
12.		R22-12	1
13.		LUX – CH - 2856G	1
14.		3,5X35 3K1SET	1
15.		6 mm Safety Glass	2
16.			

ANITA	A+B (mm)	H (mm)
80ANI	470-800	1500
90ANI	520-900	1500
100ANI	570-1000	1500
110ANI	620-1100	1500
120ANI	670-1200	1500
130ANI	720-1300	1500
140ANI	770-1400	1500
150ANI	820-1500	1500

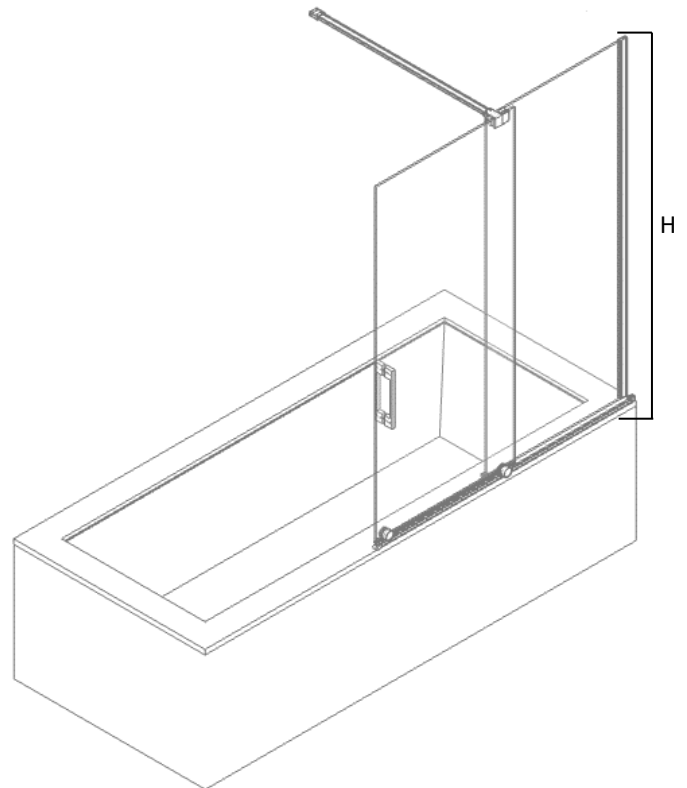

LEFT

RIGHT

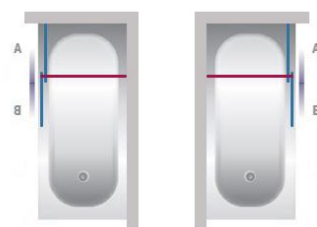

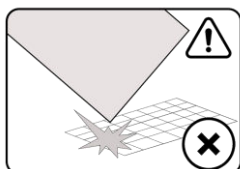
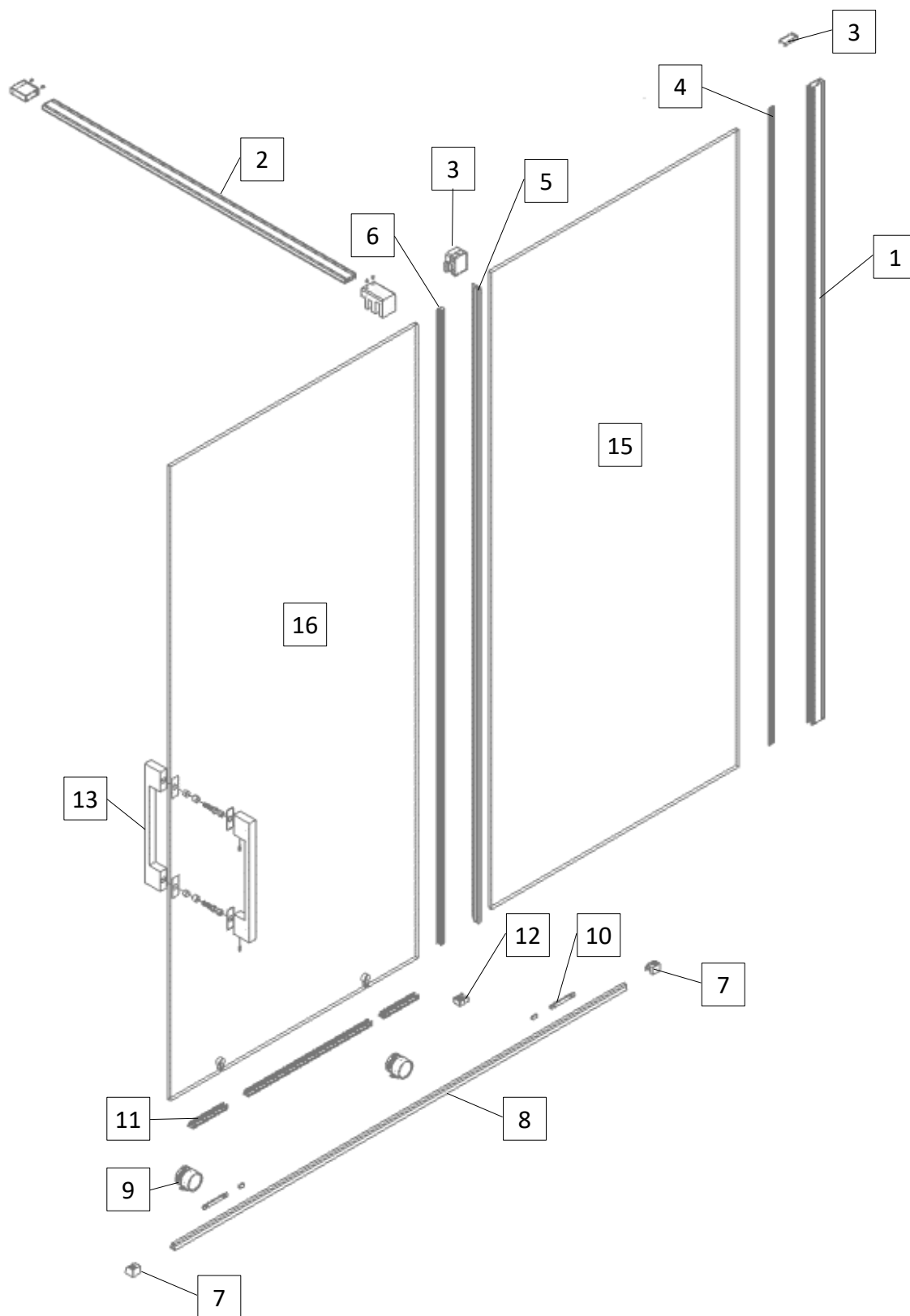

Uzmanību! Rūdīts stikls- rīkojieties uzmanīgi. Aizsargājiet stikla stūrus pret triecieniem.

Внимание! Закаленное стекло – будьте осторожны. Защищайте углы стекла от ударов.

Attention! Tempered glass - proceed with care. Protect the corners of the glass from impact.

